

0 601 944 703

Stand } 03-01-23
Issue } 03-01-23

Fig./Abb. 1

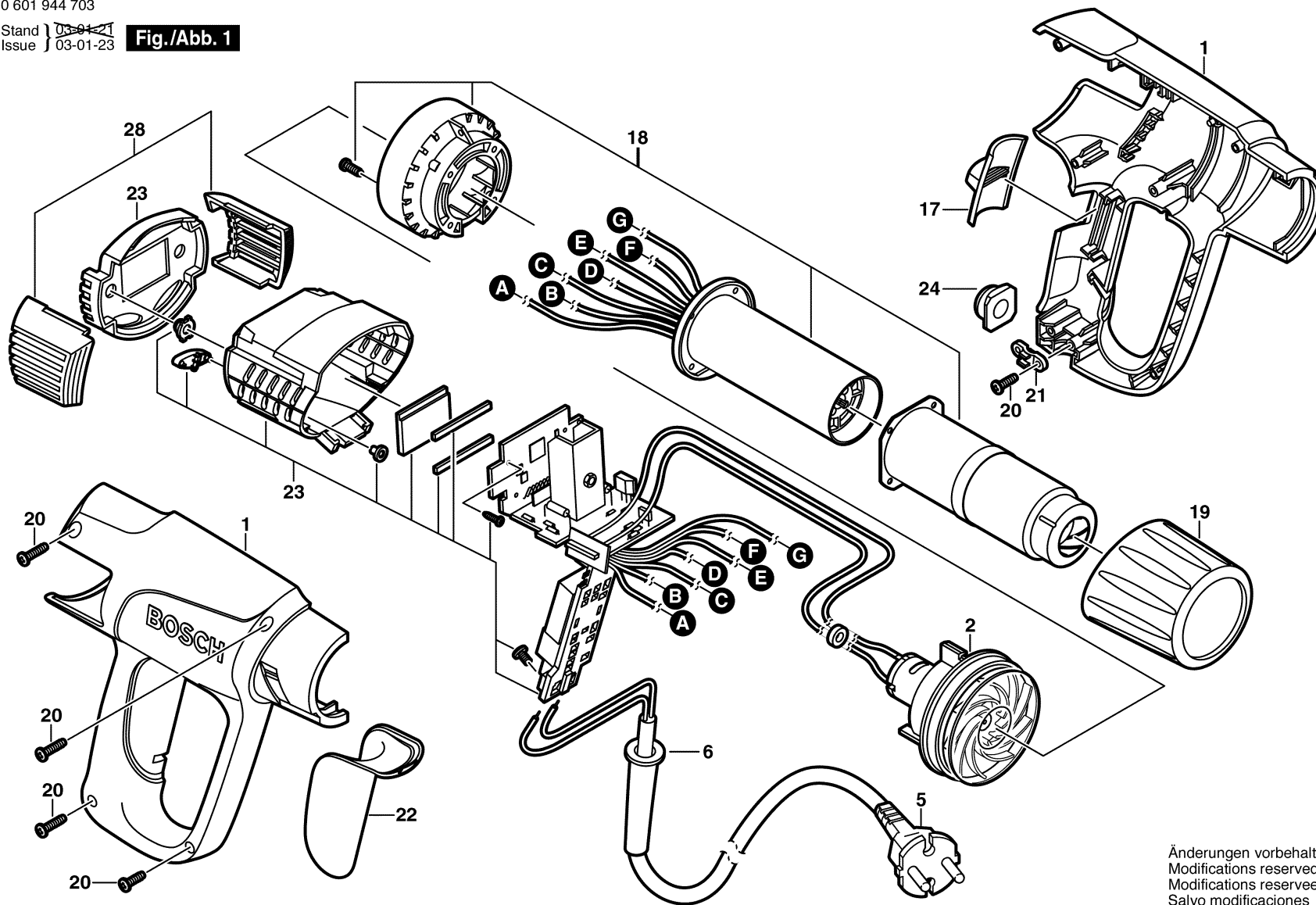

Änderungen vorbehalten
Modifications reserved
Modifications reserves
Salvo modificaciones